

**CAT/WB/MANUAL/V2**



# WARNING - MATERIAL SPECIFIC FACTS

## TITANIUM Ti6Al4V

C.A.T White Bread (WB) Titanium 5.56mm suppressors are limited to barrel lengths of 10" or longer. Full Auto or High Rates of Fire (HRF) (greater than 30 rounds per minute) are discouraged, unless in life threatening self-defense situations, as the WB Titanium is a lightweight, high performance suppressor dedicated to Low Rates of Fire (LRF). Ti6Al4V can maintain its mechanical properties up to approximately **752°F (400°C)**, and as high as **932°F (500°C)**, though with heavily reduced mechanical performance. Once the operating temperature threshold exceeds 800°F (427°C), CAT recommends a cooling down below operating temperature. Ti6Al4V has inherent material properties which give the material a lower heat conductivity rating, and the suppressor is susceptible to particle erosion and softening past operating temperature. If the user notices discoloration on the exterior discontinue use and allow it to cool down. **Do not dip the suppressor in water in an attempt to cool it down.**

C.A.T recommends WB Ti6Al4V users invest in an infrared thermometer and create their own platform specific firing schedule, based on ammunition and barrel length. It is recommended to create a firing schedule by shooting five round groups, with one second intervals between rounds, then testing the temperature of the suppressor up to the operating temperature. The user should record the cool down time until the suppressor returns to **150°F (65°C)**. This would become the baseline firing schedule based on the user's platform and ammunition type.

C.A.T WB Titanium has a dedicated "waffle" style erosion interface at the end of the blast chamber. This is a sacrificial erosion wall, and users should not be concerned if they are seeing wear, this is designed to support the erosion caused by unburnt particulates (especially in short barrel platforms) and is designed to protect other internal areas inside of the suppressor.

Excessive white sparking may be noticed upon first use, this is due to microscopic Titanium dust from the Additive Manufacturing process. Over the course of use this white sparking will subside but will never fully disappear, particularly on short barrel platforms. Titanium white sparking is separate from flash and cannot be controlled by a flash hider or other methods, as it is a byproduct of Titanium being classed as a reactive metal. If Titanium induced white sparking is an undesirable factor in the suppressor's application, C.A.T recommends the use of our Inconel 718 model offerings, as Inconel 718 doesn't spark.

## INCONEL 718

C.A.T White Bread (WB) Inconel 718 5.56mm suppressors are limited to barrel lengths of 5.5" or longer. This model is a "duty" focused suppressor, able to support Full Auto or High Rates of Fire (HRF). IN718, a nickel-chromium alloy, has excellent high-temperature properties, making it suitable for use in combat environments. IN718's typical operating temperature is approximately **1292°F (700°C)**, and can tolerate temperatures up to **1800°F (982°C)**, though prolonged exposure is not recommended. Once the operating temperature threshold is exceeded, CAT recommends a cooling down below operating temperature. The suppressor is susceptible to particle erosion and softening past operating temperature. If the user notices discoloration on the exterior discontinue use and allow it to cool down. **Do not dip the suppressor in water in an attempt to cool it down.**

C.A.T recommends WB IN718 users invest in an infrared thermometer and create their own platform specific firing schedule, based on ammunition and barrel length. It is recommended to create a firing schedule by shooting five round groups, with one second intervals between rounds, then testing the temperature of the suppressor up to the operating temperature. At the operating temperature, the user should record the amount of time until the suppressor returns to **150°F (65°C)**. This would become the baseline firing schedule based on the user's platform and ammunition type.

C.A.T WB Inconel 718 has a dedicated "waffle" style erosion interface at the end of the blast chamber. This is a sacrificial erosion wall, and users should not be concerned if they are seeing wear, this is designed to support the erosion caused by unburnt particulates (especially in short barrel platforms) and is designed to protect other internal areas inside of the suppressor.

# CAT/WB/1.375x24 HUB



**MODEL:** CAT/WB/A1  
**CALIBER:** 556NATO  
**WEIGHT TITANIUM:** 6.9 OZ (9 OZ MIL) \*  
**WEIGHT INCONEL:** 12.8 OZ ( 13.9 OZ MIL) \*  
**OVERALL LENGTH:** 5.45"  
**DIAMETER:** 1.60"  
**MIN BARREL LENGTH (TITANIUM):** 10"  
**MIN BARREL LENGTH (INCONEL):** 8"  
**OPTIMIZED VELOCITY:** 1100 – 3200FT/S  
**OPTIMIZED PLATFORM:** 14" M4  
**TECHNOLOGY:** SURGE BYPASS  
**RECOMMENDATION:** SEMI-AUTO  
**FINISH:** DLC  
**MOUNTING:** 1/2×28 DIRECT THREAD (INCLUDED)

## INSTALLATION

### STEP 1

Remove the magazine from the firearm, then visually and manually check and clear the action and chamber of the firearm. Ensure the host firearm is unloaded at all times.

### STEP 2

Always ensure the barrel thread and shoulders are clean and free of debris.  
To install the CAT 1×16LH QD muzzle device, clean and degrease barrel threads and make sure barrel shoulder is also clean (pink surfaces).

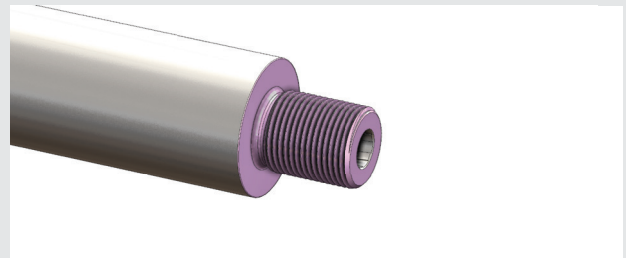

## IF USING THE INCLUDED 5/8X24 DIRECT THREAD MOUNT:

### STEPS 3,4 & 5

Prior to installing the 5/8×24 direct thread mount on the suppressor, inspect the mounting interface surfaces of the direct thread mount and ensure the threads and shoulders are clean and free of debris (gold and green surfaces). Ensure the CAT WB suppressor internal 1-3/8×24 (1.375×24) thread is clean and free of debris (blue).



# INSTALLATION

## STEPS 6,7 & 8

Screw the direct thread mount into the back of the CAT WB suppressor and torque it down, with a 1-1/2" (1.500") wrench on the CAT WB wrench flats and a 7/8" (.875") wrench on the direct thread mount wrench flats, to 25-30ft/lb. If you choose to use a thread locker between the direct thread mount and the CAT WB, degrease the threads and allow the thread locker to fully cure before using the firearm.

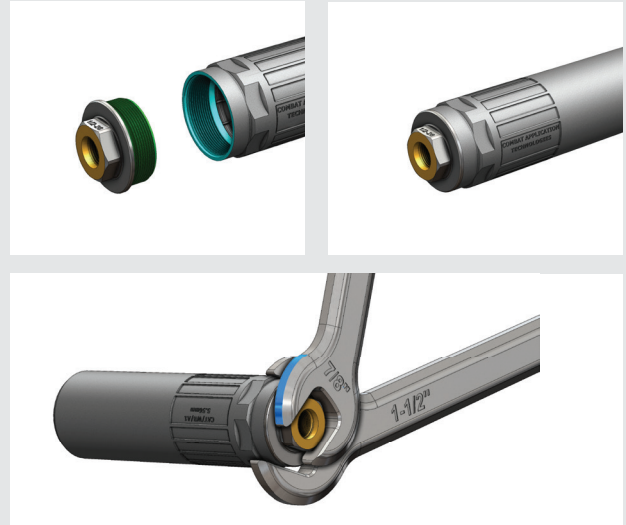

## STEPS 9 & 10

To install the CAT WB with direct thread mount assembly onto the firearm, again ensure the firearm is completely unloaded and safe, then slide the assembly over the barrel and thread it on CLOCKWISE (right hand to tighten) torquing it down first by hand like you don't want it to come off, tightening the CAT WB direct thread mount assembly fully against the barrel shoulder. When installed by hand, you must check the suppressor repeatedly during use to ensure it doesn't come loose. To ensure the assembly won't come loose, torque the direct thread mount down to the barrel using a 7/8" (.875") wrench to 25-30ft/lb. If you choose to use a thread locker between the direct thread mount and the CAT WB, degrease the threads and allow the thread locker to fully cure before using the firearm.

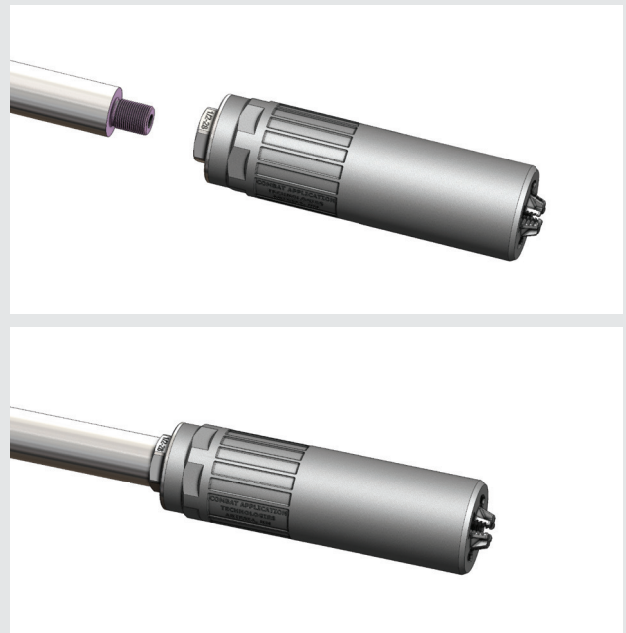

## STEPS 11 & 12

Visually inspect that the CAT WB with direct thread mount assembly is properly installed on the firearm barrel and that it's mounted straight to the centerline of the bore. Ensure the suppressor isn't canted in any way and that the CAT WB is fully shouldered against the barrel shoulder.

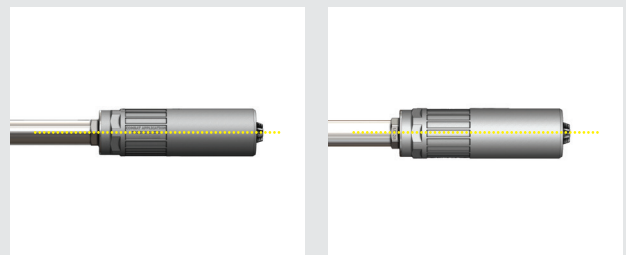

# INSTALLATION

## STEPS 13 & 14

Use a properly made, purpose built suppressor alignment rod to ensure the suppressor is properly mounted and concentric to the bore line.

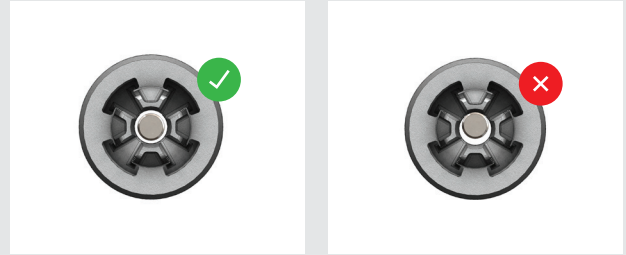

**\*To remove the CAT WB with direct thread mount assembly from the host firearm barrel, wait for the suppressor to cool after use, ensure the firearm is completely unloaded and safe, then unscrew the suppressor COUNTER CLOCKWISE (left hand to loosen). If you experience the direct mount coming loose from the WB suppressor body, you may need to use additional torque between the two parts within spec, or you may use an optional thread locker. If you choose to use a thread locker between the direct thread mount and the CAT WB, degrease the threads and allow the thread locker to fully cure before using the firearm.**

## IF USING THE CAT TSFX QD MOUNT (SOLD SEPARATELY):

### STEPS 1 & 2

Prior to installing the CAT TSFX QD mount in the suppressor, inspect the mounting interface surfaces of the CAT TSFX QD mount and ensure the critical mounting surfaces are clean and free of debris (red/blue surfaces internal and green surfaces external - pay special attention to making sure the blue internal taper shoulder region is clean and free of debris). Ensure the CAT WB suppressor internal 1-3/8x24 (1.375x24) thread is clean and free of debris (blue).



### STEPS 3,4 & 5

Screw the CAT TSFX QD mount into the back of the CAT WB suppressor and torque it down, with a 1-1/2" (1.500") wrench on the CAT WB wrench flats and a 1-3/16" (1.1875") wrench on the CAT TSFX QD mount wrench flats, to 25-30ft/lb. If you choose to use a thread locker between the CAT TSFX QD mount and the CAT WB, degrease the threads and allow the thread locker to fully cure before using the suppressor on a firearm.



# INSTALLATION

## STEP 6

Inspect the muzzle device and ensure the critical surfaces are clean and free of debris (green surfaces, especially the taper shoulder).



## STEPS 7 & 8

To install the CAT WB with CAT TSFX QD mount assembly onto the firearm, again ensure the firearm is completely unloaded and safe, then slide the assembly over the CAT 1×16LH QD muzzle device (sold separately) and thread it on COUNTER-clockwise (left hand to tighten) and tighten the CAT WB strongly by hand to the muzzle device like you don't want it to come off, tightening the CAT WB fully against its taper shoulder interface. When WB is properly installed this taper shoulder interface will prevent loosening during use. If you choose to use a thread locker between the CAT TSFX QD mount and the CAT WB, degrease the threads and allow the thread locker to fully cure before using the firearm.



## STEPS 9 & 10

Visually inspect that the CAT WB with CAT TSFX QD mount assembly is properly installed on the muzzle device and that it's mounted straight to the centerline of the bore. Ensure the suppressor isn't canted in any way and that the CAT WB is fully shouldered against the taper on the muzzle device.

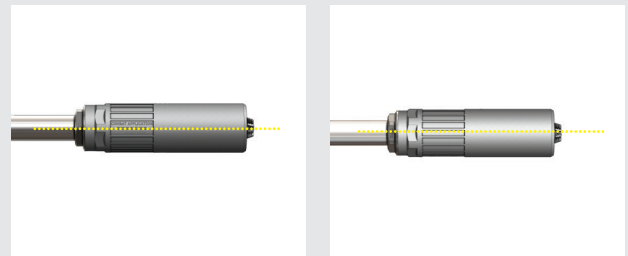

## STEPS 11 & 12

Use a properly made, purpose built suppressor alignment rod to ensure the suppressor is properly mounted and concentric to the bore line.

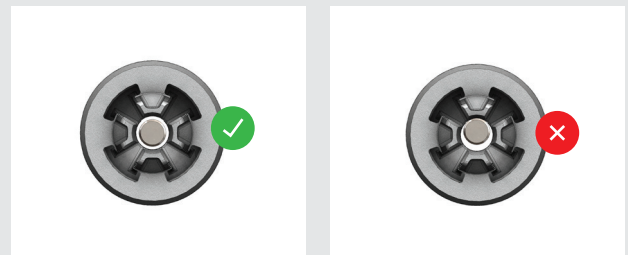

**\*To remove the CAT WB with CAT TSFX QD mount assembly from the muzzle device, wait for the suppressor to cool after use, ensure the firearm is completely unloaded and safe, then unscrew the suppressor CLOCKWISE (right hand to loosen). Left hand threads are used on the CAT 1×16LH QD muzzle devices so that when uninstalling the suppressor, the QD muzzle device will always stay on the host firearm rather than coming off and becoming stuck inside the suppressor. If you experience the TSFX mount coming loose from the WB suppressor body, you may need to use additional torque between the two parts within spec, or you may use an optional thread locker. If you choose to use a thread locker between the direct thread mount and the CAT WB, degrease the threads and allow the thread locker to fully cure before using the firearm.**



# CAT/WB/1x16LH QD



**MODEL:** CAT/WB/A1  
**CALIBER:** 556NATO  
**WEIGHT TITANIUM:** 7.8 OZ (9.4 OZ MIL) \*  
**WEIGHT INCONEL:** 14.4 OZ (16.8 OZ MIL) \*  
**OVERALL LENGTH:** 5.80"  
**DIAMETER:** 1.60"  
**MIN BARREL LENGTH (TITANIUM):** 10"  
**MIN BARREL LENGTH (INCONEL):** 8"  
**OPTIMIZED VELOCITY:** 1100 – 3200FT/S  
**OPTIMIZED PLATFORM:** 14" M4  
**TECHNOLOGY:** SURGE BYPASS  
**RECOMMENDATION:** SEMI-AUTO  
**FINISH:** DLC  
**MOUNTING:** SPOOKY 1 (INCLUDED)

## INSTALLATION

### STEP 1

Remove the magazine from the firearm, then visually and manually check and clear the action and chamber of the firearm. Ensure the host firearm is unloaded at all times.

---

### STEP 2

Always ensure the barrel thread and shoulders are clean and free of debris. To install the CAT 1×16LH QD muzzle device, clean and degrease barrel threads and make sure barrel shoulder is also clean (pink surfaces).

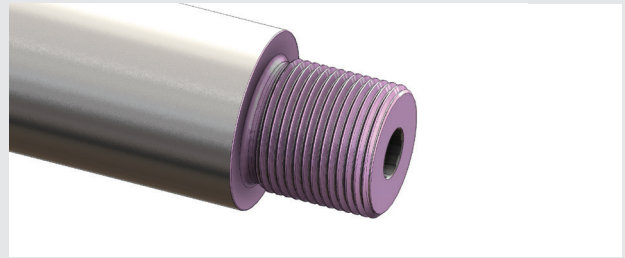

### STEP 3

Ensure the CAT 1×16LH QD muzzle device internal thread and shoulders are clean, degreased, and free of debris (gold surfaces). Coat the barrel threads with a high temperature thread locker, such as Rocksett, according to that manufacturers instructions.



### STEPS 4 & 5

Screw the CAT 1×16LH QD muzzle device onto the barrel threads and torque it down with an 11/16" (.688") wrench to 25-30ft/lb. Allow the thread locker to fully cure before using the suppressor on a firearm.





# INSTALLATION

## STEP 6

Inspect the muzzle device and ensure the critical surfaces are clean and free of debris (green surfaces, especially the taper shoulder).



## STEP 7

Prior to installing the CAT WB on the muzzle device, inspect the internal mounting surfaces of the CAT WB and ensure the critical mounting surfaces are clean and free of debris (red surfaces - pay special attention to making sure the blue taper shoulder region is clean and free of debris).

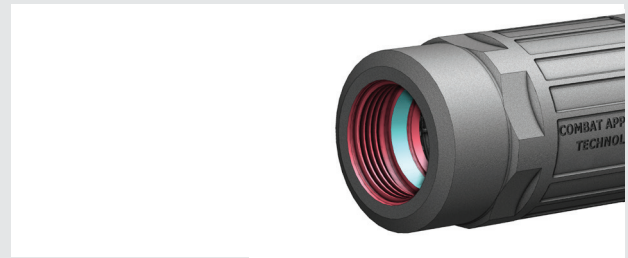

## STEPS 8 & 9

To install the CAT WB, slide it over the muzzle device and thread COUNTER-clockwise (left hand to tighten) and tighten the CAT WB strongly by hand to fully engage the taper shoulder interfaces. When CAT WB is properly installed this taper shoulder interface will prevent loosening during use but it is highly recommended that users continue to check between cooling periods, as dirt and heat expansion can sometimes lead to interface separation.



## STEPS 10 & 11

Visually inspect that the CAT WB is properly installed on the muzzle device and that it's mounted straight to the centerline of the bore. Ensure the suppressor isn't canted in any way and that the CAT WB is fully shouldered against the taper on the muzzle device.

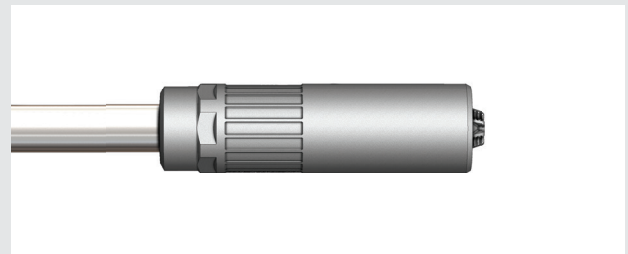

## STEPS 12 & 13

Use a properly made, purpose built suppressor alignment rod to ensure the suppressor is properly mounted and concentric to the bore line.

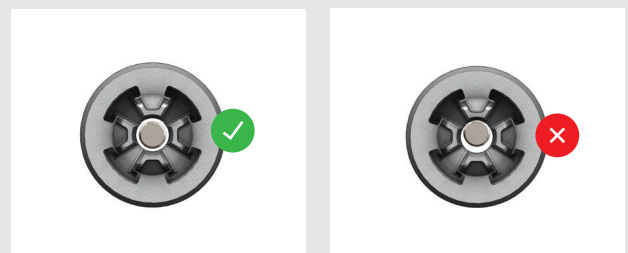

**\*To remove the CAT WB from the muzzle device, wait for the suppressor to cool after use, ensure the firearm is completely unloaded and safe, then unscrew the suppressor CLOCKWISE (right hand to loosen). Left hand threads are used on the CAT 1×16LH QD muzzle devices so that when uninstalling the suppressor, the QD muzzle device will always stay on the host firearm rather than coming off and becoming stuck inside the suppressor.**

